

ERGO 140 incl. Safety break resistance

PCSCHEMATIC Automation

A/S WODSCHOW & Co.
Kirkebjerg Søpark 6
DK-2605 Brøndby, Denmark
www.bearvarimixer.dk



Project title: ERGO 140	Case no.:	Project rev.:	Page 1
Customer:			Scale: 1:1
Page title: front page	Dwg. no.:	Page rev.:	Previous page:
File name: 34.140-10.03.04_external_use	Eng. (proj/page): CE / CE	Last print: 22-12-2017	Next page: 2
Page ref.:	Appr. (date/init):	Last edit: 28-12-2016	Total no. of pages: 25

Documentation Info

This electrical documentation fits ERGO 140

- Includes brake resistance
- ENG. version
- CE approval
- Safety relay delayed stop function

Notes

There will be several variants of charts like this:

- 1: With and without brakes
- 2: With and without transformer
- 3: UL or CE approvals

Further, it should be noted that there will be some old versions which will be phase objections along the way, this problem will this be rectified.

Revision descriptions

- Rev. 01 Drawing. no. 01, page 5 & 7: Brake Resistance + Safety relay incl. delay stop function added



Project title: ERGO 140	Case no.:	Project rev.:	Page 4
Customer:	DCC: &DB		Scale: 1:1
Page title: Diagram	Dwg. no.:	Page rev.:	Previous page: 3
File name: 34.140-10.03.04_external_use	Eng. (proj/page): CE	Last print: 22-12-2017	Next page: 5
Page ref.:	Appr. (date/init):	Last edit: 21-12-2017	Total no. of pages: 25

Diagram

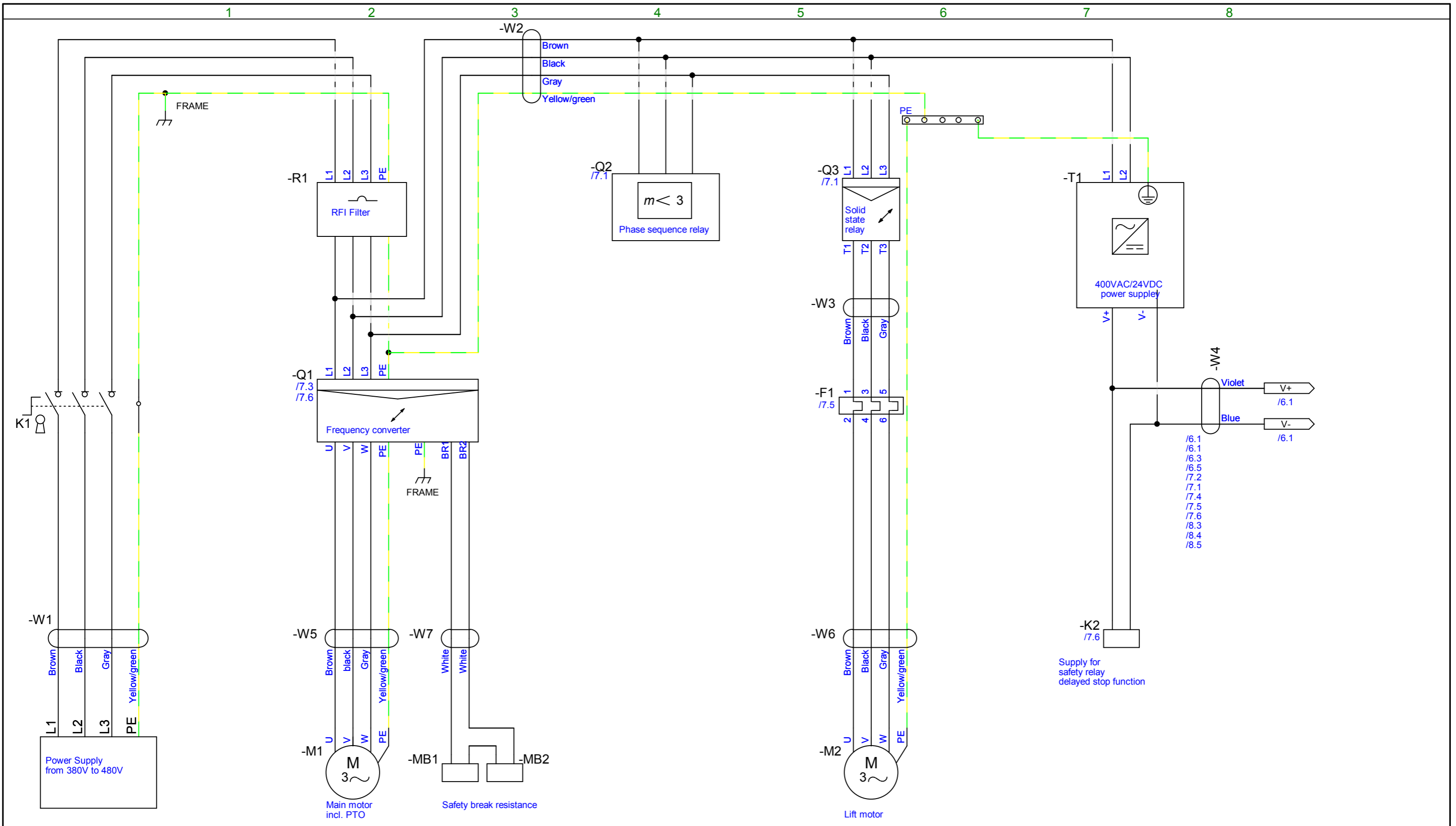

Project title: ERGO 140	Case no.:	Project rev.:	Page 5
Customer:	DCC: &FS		Scale: 1:1
Page title: Diagram	Dwg. no.: 01	Page rev.: 01	Previous page: 4
File name: 34.140-10.03.04_external_use	Eng. (proj/page): CE / CE	Last print: 22-12-2017	Next page: 6
Page ref.:	Appr. (date/init):	Last edit: 22-12-2017	Total no. of pages: 25

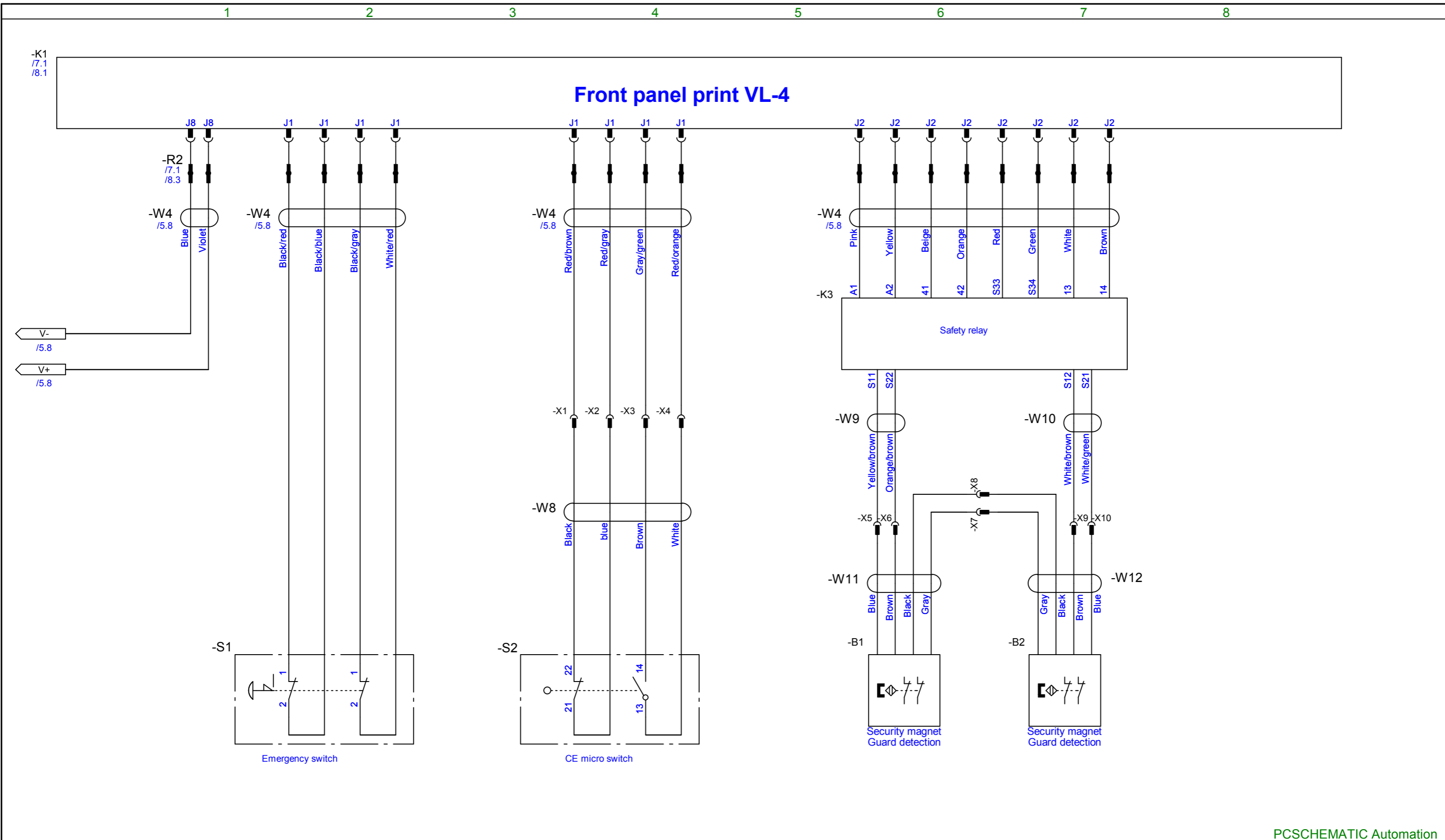

Project title: ERGO 140	Case no.:	Project rev.:	Page 6
Customer:	DCC: &FS		Scale: 1:1
Page title: Diagram	Dwg. no.: 02	Page rev.:	Previous page: 5
File name: 34.140-10.03.04_external_use	Eng. (proj/page): CE / CE	Last print: 22-12-2017	Next page: 7
Page ref.:	Appr. (date/init):	Last edit: 21-12-2017	Total no. of pages: 25

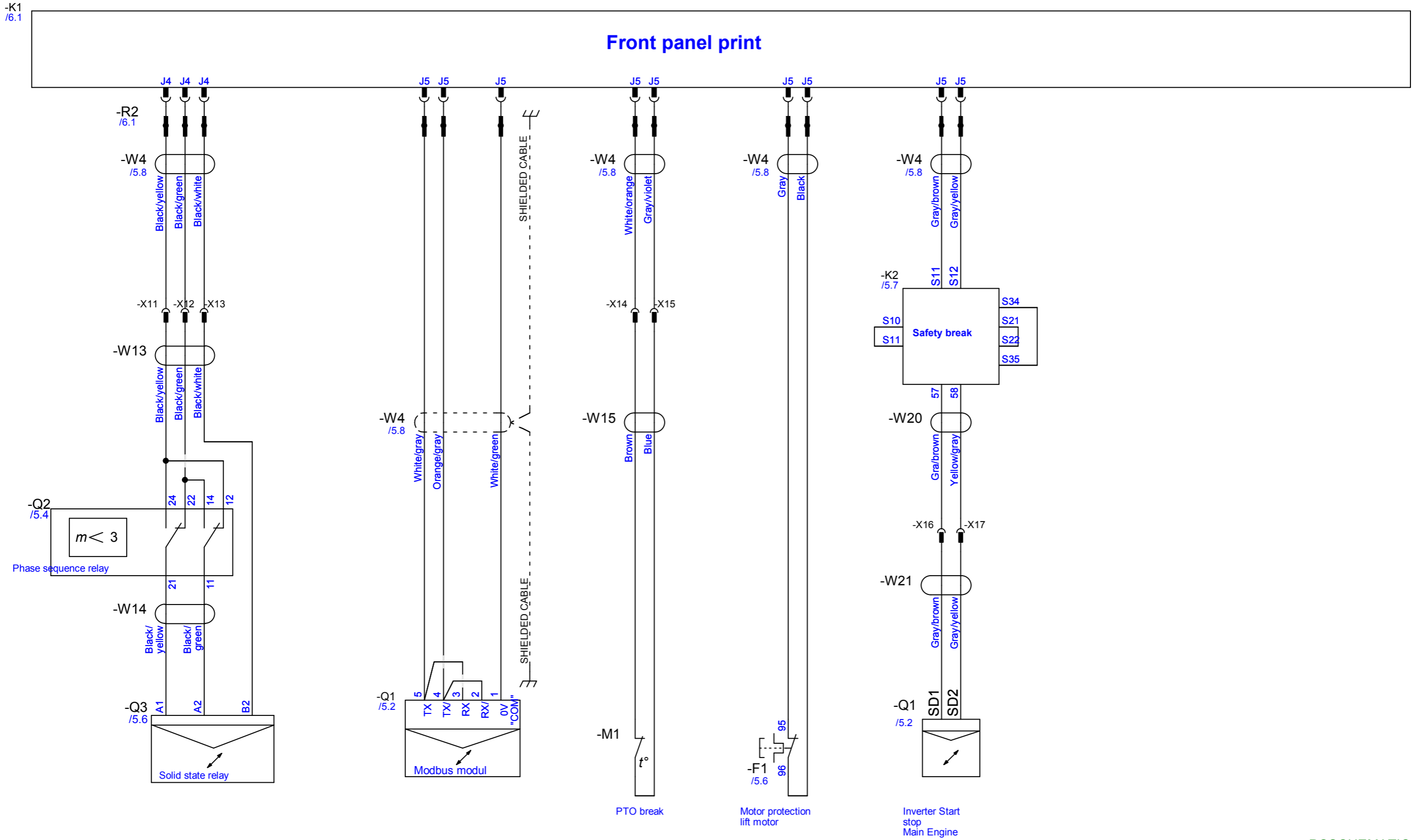

Project title: ERGO 140	Case no.:	Project rev.:	Page 7
Customer:	DCC: &FS		Scale: 1:1
Page title: Diagram	Dwg. no.: 03	Page rev.: 01	Previous page: 6
File name: 34.140-10.03.04_external_use	Eng. (proj/page): CE / CE	Last print: 22-12-2017	Next page: 8
Page ref.:	Appr. (date/init):	Last edit: 21-12-2017	Total no. of pages: 25

-K1
/6.1
/7.1

Front panel print

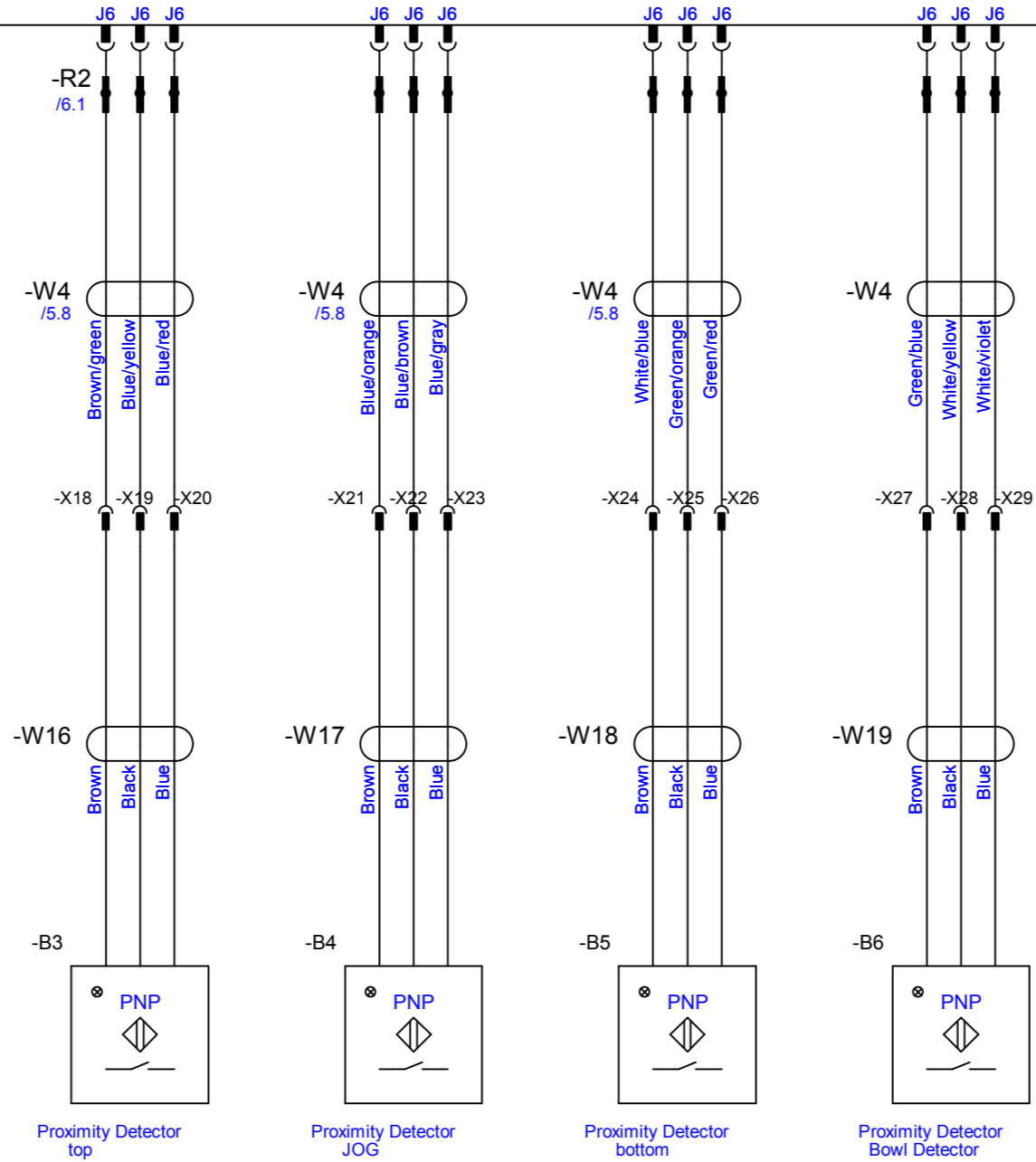

Project title: ERGO 140	Case no.:	Project rev.:	Page 8
Customer:	DCC: &FS		Scale: 1:1
Page title: Diagram	Dwg. no.: 04	Page rev.:	Previous page: 7
File name: 34.140-10.03.04_external_use	Eng. (proj/page): CE / CE	Last print: 22-12-2017	Next page: 9
Page ref.:	Appr. (date/init):	Last edit: 21-12-2017	Total no. of pages: 25

Lists

Component	Article	Type	Description	Position
				/5.6
-B1	AE140-512M	Guard detection		/6.6
-B2	AE140-512M	Guard detection		/6.7
-B3	AE140-86.1M	Magnet induktiv sensor		/8.3
-B4	AE140-86.1M	Magnet induktiv sensor		/8.4
-B5	AE140-86.1M	Magnet induktiv sensor		/8.5
-B6	R20E-501.7	Magnet induktiv sensor		/8.6
-F1	AE140-420.4	Safety relay		/5.6
-K1	AE140-561	Print for VL4 panel		/6.1
-K2	AE140-420.2	Safety Relay delayed stop function		/7.6
-K3	AE140-420	Safety relay		/6.5
-M1	AE140-85	Main motor incl. PTO		/5.2
-M2	AE140-86Z	Lift motor		/5.6
-MB1	CE61-175M	Safety break resistance		/5.3
-Q1	AE140-601	Inverter 5,5kW		/5.2
-Q2	CE61-420.4	Phase sequence relay		/5.4
-Q3	AE140-420.3	Solid state relay		/5.6
-R1	AE140-601.1	RFI Filter		/5.2
-R2	AE140-601.8	Permanent magnet		/6.1
-S1	CE61-174	Emergency in front panel		/6.2
-S2	CE61-173.1M	Micro switch CE		/6.3
-T1	CE61-414	24VDC Power supply 400VSC/24VDC		/5.7
-W1	AE140-194.14M	POWER		/5.1
-W4	AE140-542.6	24VDC main circuit cable		/5.8

PCSCHEMATIC Automation

A/S WODSCHOW & Co.

Kirkebjerg Søpark 6
DK-2605 Brøndby, Denmark
www.bearvarimixer.dk



Project title: ERGO 140	Case no.:	Project rev.:	Page 10
Customer:	DCC: &PD		Scale: 1:1
Page title: Component list	Dwg. no.:	Page rev.:	Previous page: 9
File name: 34.140-10.03.04_external_use	Eng. (proj/page): CE / CE	Last print: 22-12-2017	Next page: 11
Page ref.:	Appr. (date/init):	Last edit: 21-12-2017	Total no. of pages: 25

From	Cable	To	Type
POWER L2 /5.1	-W1 Black	K1 4 /5.1	POWER
POWER L1 /5.1	-W1 Brown	K1 2 /5.1	POWER
POWER L3 /5.1	-W1 Gray	K1 6 /5.1	POWER
POWER PE /5.1	-W1 Yellow/green	K1 8 /5.1	POWER
-Q1 L2 /5.2	-W2 Black	-Q3 L2 /5.6	Mellemleder
-Q1 L1 /5.2	-W2 Brown	-Q2 A2 /5.4	Mellemleder
-Q1 L3 /5.2	-W2 Gray	-Q3 L3 /5.6	Mellemleder
-R1 8 /5.2	-W2 Yellow/green	/5.6	Mellemleder
-Q3 T2 /5.6	-W3 Black	-F1 3 /5.6	Conductor
-Q3 T1 /5.5	-W3 Brown	-F1 1 /5.5	Conductor
-Q3 T3 /5.6	-W3 Gray	-F1 5 /5.6	Conductor
-R2 0 /6.6	-W4 Beige	-K3 41 /6.6	Cable to safety relay
-R2 0 /6.7	-W4 Brown	-K3 14 /6.7	Cable to safety relay
-R2 0 /6.7	-W4 Green	-K3 S34 /6.7	Cable to safety relay
-R2 0 /6.6	-W4 Orange	-K3 42 /6.6	Cable to safety relay
-R2 0 /6.5	-W4 Pink	-K3 A1 /6.5	Cable to safety relay
-R2 0 /6.6	-W4 Red	-K3 S33 /6.6	Cable to safety relay
-R2 0 /6.7	-W4 White	-K3 13 /6.7	Cable to safety relay
-R2 0 /6.6	-W4 Yellow	-K3 A2 /6.6	Cable to safety relay
-R2 0 /7.5	-W4 Black	-F1 96 /7.5	Cable termoe relay
-R2 0 /7.5	-W4 Gray	-F1 95 /7.5	Cable termoe relay
-R2 0 /6.2	-W4 Black/blue	-S1 2 /6.1	Conductor, emergency stop to the front panel
-R2 0 /6.2	-W4 Black/gray	-S1 1 /6.2	Conductor, emergency stop to the front panel
-R2 0 /6.1	-W4 Black/red	-S1 1 /6.1	Conductor, emergency stop to the front panel
-R2 0 /6.2	-W4 White/red	-S1 2 /6.2	Conductor, emergency stop to the front panel

PCSCHEMATIC Automation



From			Cable		To			Type
-R2	0	/7.1	-W4	Black/green	-X12	0	/7.1	
-R2	0	/7.1	-W4	Black/white	-X13	0	/7.1	
-R2	0	/7.1	-W4	Black/yellow	-X11	0	/7.1	
-K2	A2	/5.7	-W4	Blue	-R2	0	/6.1	24VDC main circuit cable
-K2	A1	/5.7	-W4	Violet	-R2	0	/6.1	24VDC main circuit cable
-R2	0	/8.4	-W4	Blue/brown	-X22	0	/8.4	Cable PNP JOG
-R2	0	/8.4	-W4	Blue/gray	-X23	0	/8.4	Cable PNP JOG
-R2	0	/8.4	-W4	Blue/orange	-X21	0	/8.4	Cable PNP JOG
-R2	0	/8.3	-W4	Blue/red	-X20	0	/8.3	Cable PNP top
-R2	0	/8.3	-W4	Blue/yellow	-X19	0	/8.3	Cable PNP top
-R2	0	/8.3	-W4	Brown/green	-X18	0	/8.3	Cable PNP top
-R2	0	/7.6	-W4	Gray/brown	-K2	S11	/7.6	Start/stop
-R2	0	/7.6	-W4	Gray/yellow	-K2	S12	/7.6	Start/stop
-R2	0	/6.4	-W4	Gray/green	-X3	0	/6.4	Cable micro switch
-R2	0	/6.3	-W4	Red/brown	-X1	0	/6.3	Cable micro switch
-R2	0	/6.4	-W4	Red/gray	-X2	0	/6.4	Cable micro switch
-R2	0	/6.4	-W4	Red/orange	-X4	0	/6.4	Cable micro switch
-R2	0	/7.4	-W4	Gray/violet	-X15	0	/7.4	Cable to PTO
-R2	0	/7.4	-W4	White/orange	-X14	0	/7.4	Cable to PTO
-R2	0	/8.6	-W4	Green/blue	-X27	0	/8.6	Cable PNP Bowl
-R2	0	/8.6	-W4	White/violet	-X29	0	/8.6	Cable PNP Bowl
-R2	0	/8.6	-W4	White/yellow	-X28	0	/8.6	Cable PNP Bowl
-R2	0	/8.5	-W4	Green/orange	-X25	0	/8.5	Cable PNP bund
-R2	0	/8.5	-W4	Green/red	-X26	0	/8.5	Cable PNP bund
-R2	0	/8.5	-W4	White/blue	-X24	0	/8.5	Cable PNP bund
-R2	0	/7.3	-W4	Orange/gray	-Q1	4	/7.3	Shielded cable
-R2	0	/7.3	-W4	White/gray	-Q1	5	/7.3	Shielded cable
-R2	0	/7.3	-W4	White/green	-Q1	1	/7.3	Shielded cable

PCSCHEMATIC Automation



Project title: ERGO 140	Case no.:	Project rev.:	Page 12
Customer:	DCC: &MA		Scale: 1:1
Page title: Cable list	Dwg. no.:	Page rev.:	Previous page: 11
File name: 34.140-10.03.04_external_use	Eng. (proj/page): CE / CE	Last print: 22-12-2017	Next page: 13
Page ref.:	Appr. (date/init):	Last edit: 21-12-2017	Total no. of pages: 25

From			Cable		To			Type
			-W4					Shielded cable
-Q1	U	/5.2	-W5	Brown	-M1	U	/5.2	Cable main motor
-Q1	W	/5.2	-W5	Gray	-M1	W	/5.2	Cable main motor
-Q1	PE	/5.2	-W5	Yellow/green	-M1	PE	/5.2	Cable main motor
-Q1	V	/5.2	-W5	black	-M1	V	/5.2	Cable main motor
-F1	4	/5.6	-W6	Black	-M2	V	/5.6	Cable for lift motor
-F1	2	/5.5	-W6	Brown	-M2	U	/5.5	Cable for lift motor
-F1	6	/5.6	-W6	Gray	-M2	W	/5.6	Cable for lift motor
		/5.6	-W6	Yellow/green	-M2	PE	/5.6	Cable for lift motor
-Q1	BR2	/5.3	-W7	White	-MB2	A2	/5.3	Safety break resistance wire
-Q1	BR1	/5.3	-W7	White	-MB1	A1	/5.3	Safety break resistance wire
-X1	0	/6.3	-W8	Black	-S2	22	/6.3	Cable micro switch
-X3	0	/6.4	-W8	Brown	-S2	14	/6.4	Cable micro switch
-X4	0	/6.4	-W8	White	-S2	13	/6.4	Cable micro switch
-X2	0	/6.4	-W8	blue	-S2	21	/6.3	Cable micro switch
-K3	S22	/6.6	-W9	Orange/brown	-X6	0	/6.6	Conductor
-K3	S11	/6.6	-W9	Yellow/brown	-X5	0	/6.6	Conductor
-K3	S12	/6.7	-W10	White/brown	-X9	0	/6.7	Conductor
-K3	S21	/6.7	-W10	White/green	-X10	0	/6.7	Conductor
-X8	0	/6.6	-W11	Black	-B1	3	/6.6	Cable bowl detection
-X5	0	/6.6	-W11	Blue	-B1	1	/6.6	Cable bowl detection

PCSCHEMATIC Automation



From			Cable		To			Type
-X6	0	/6.6	-W11	Brown	-B1	2	/6.6	Cable bowl detection
-X7	0	/6.6	-W11	Gray	-B1	4	/6.6	Cable bowl detection
-X8	0	/6.6	-W12	Black	-B2	2	/6.7	Cable bowldetection
-X10	0	/6.7	-W12	Blue	-B2	4	/6.7	Cable bowldetection
-X9	0	/6.7	-W12	Brown	-B2	3	/6.7	Cable bowldetection
-X7	0	/6.6	-W12	Gray	-B2	1	/6.7	Cable bowldetection
-X12	0	/7.1	-W13	Black/green	-Q2	14	/7.1	Conductor
-X13	0	/7.1	-W13	Black/white	-Q3	B2	/7.1	Conductor
-X11	0	/7.1	-W13	Black/yellow	-Q2	12	/7.1	Conductor
-Q2	11	/7.1	-W14	Black/ green	-Q3	A2	/7.1	Conductor
-Q2	21	/7.1	-W14	Black/ yellow	-Q3	A1	/7.1	Conductor
-X15	0	/7.4	-W15	Blue	-M1	2	/7.4	PTO kabel
-X14	0	/7.4	-W15	Brown	-M1	1	/7.4	PTO kabel
-X19	0	/8.3	-W16	Black	-B3		/8.3	PNP Sensor cable top
-X20	0	/8.3	-W16	Blue	-B3		/8.3	PNP Sensor cable top
-X18	0	/8.3	-W16	Brown	-B3		/8.3	PNP Sensor cable top
-X22	0	/8.4	-W17	Black	-B4		/8.4	PNP Sensor cable JOG
-X23	0	/8.4	-W17	Blue	-B4		/8.4	PNP Sensor cable JOG
-X21	0	/8.4	-W17	Brown	-B4		/8.4	PNP Sensor cable JOG
-X25	0	/8.5	-W18	Black	-B5		/8.5	PNP Sensor cable bottom
-X26	0	/8.5	-W18	Blue	-B5		/8.5	PNP Sensor cable bottom



Project title: ERGO 140	Case no.:	Project rev.:	Page 14
Customer:	DCC: &MA		Scale: 1:1
Page title: Cable list	Dwg. no.:	Page rev.:	Previous page: 13
File name: 34.140-10.03.04_external_use	Eng. (proj/page): CE / CE	Last print: 22-12-2017	Next page: 15
Page ref.:	Appr. (date/init):	Last edit: 22-12-2017	Total no. of pages: 25

From			Cable		To		Type
-X24	0	/8.5	-W18	Brown	-B5	/8.5	PNP Sensor cable bottom
-X28	0	/8.6	-W19	Black	-B6	/8.6	PNP Sensor cable bowl
-X29	0	/8.6	-W19	Blue	-B6	/8.6	PNP Sensor cable bowl
-X27	0	/8.6	-W19	Brown	-B6	/8.6	PNP Sensor cable bowl
-K2	57	/7.6	-W20	Gra/brown	-X16	0	Conductor
-K2	58	/7.6	-W20	Yellow/gray	-X17	0	Conductor
-X16	0	/7.6	-W21	Gray/brown	-Q1	SD1	Conductor
-X17	0	/7.6	-W21	Gray/yellow	-Q1	SD2	Conductor



Project title: ERGO 140	Case no.:	Project rev.:	Page 15
Customer:	DCC: &MA		Scale: 1:1
Page title: Cable list	Dwg. no.:	Page rev.:	Previous page: 14
File name: 34.140-10.03.04_external_use	Eng. (proj/page): CE / CE	Last print: 22-12-2017	Next page: 16
Page ref.:	Appr. (date/init):	Last edit: 22-12-2017	Total no. of pages: 25

Page no.	Title	Page remarks	Revision	Last edit
1	front page			28-12-2016
2	Indeks			28-12-2016
3	Table of contents			22-12-2017
4	Diagram			21-12-2017
	Diagram			
5	Diagram		01	21-12-2017
6	Diagram			21-12-2017
7	Diagram		01	21-12-2017
8	Diagram			21-12-2017
	Lists			
9	Parts List			21-12-2017
10	Component list			21-12-2017
11	Cable list			21-12-2017
16	Comments (log)			22-12-2017

PCSCHEMATIC Automation



Page no.	Title	Page remarks	Revision	Last edit
	Arrangement			
18	Component placement			22-12-2017
19	Cable connection			22-12-2017
	PCB diagram			
20	Diagram			22-12-2017
21	Diagram			22-12-2017

PCSCHEMATIC Automation



Project title: ERGO 140	Case no.:	Project rev.:	Page 17
Customer:			Scale: 1:1
Page title: Comments (log)	Dwg. no.:	Page rev.:	Previous page: 16
File name: 34.140-10.03.04_external_use	Eng. (proj/page): CE	Last print: 22-12-2017	Next page: 18
Page ref.:	Appr. (date/init):	Last edit: 22-12-2017	Total no. of pages: 25

Arrangement

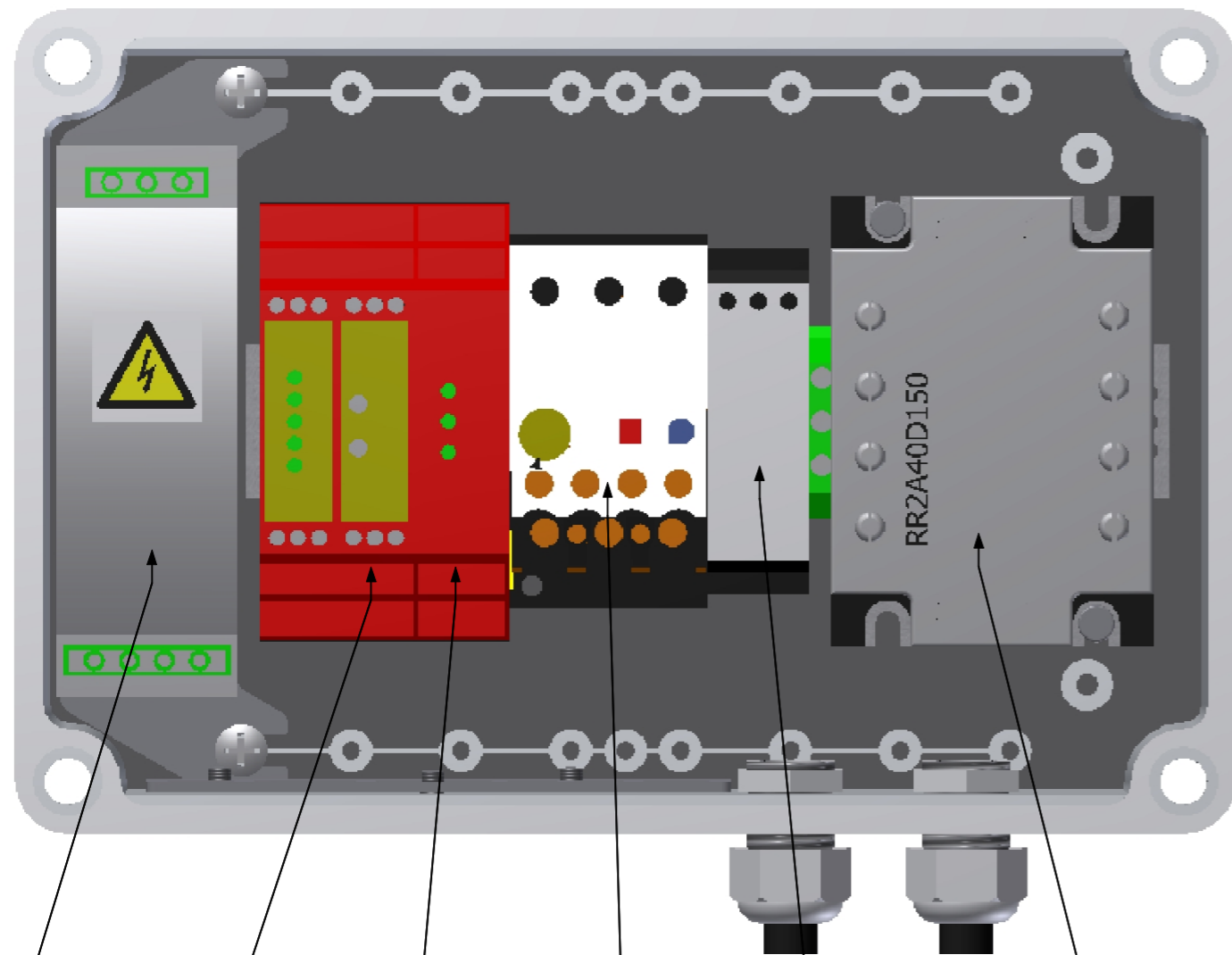

400VAC/24VDC
power supply
Part no. CE61-414

Safety relay
delayed
stop function
Part no. AE140-420.2

Safety relay
Part no. AE140-420

Safety relay
part no. AE140-420.4

Phase sequence relay
part no. CE61-420.4

Solid state relay
part no. CE140-420.3

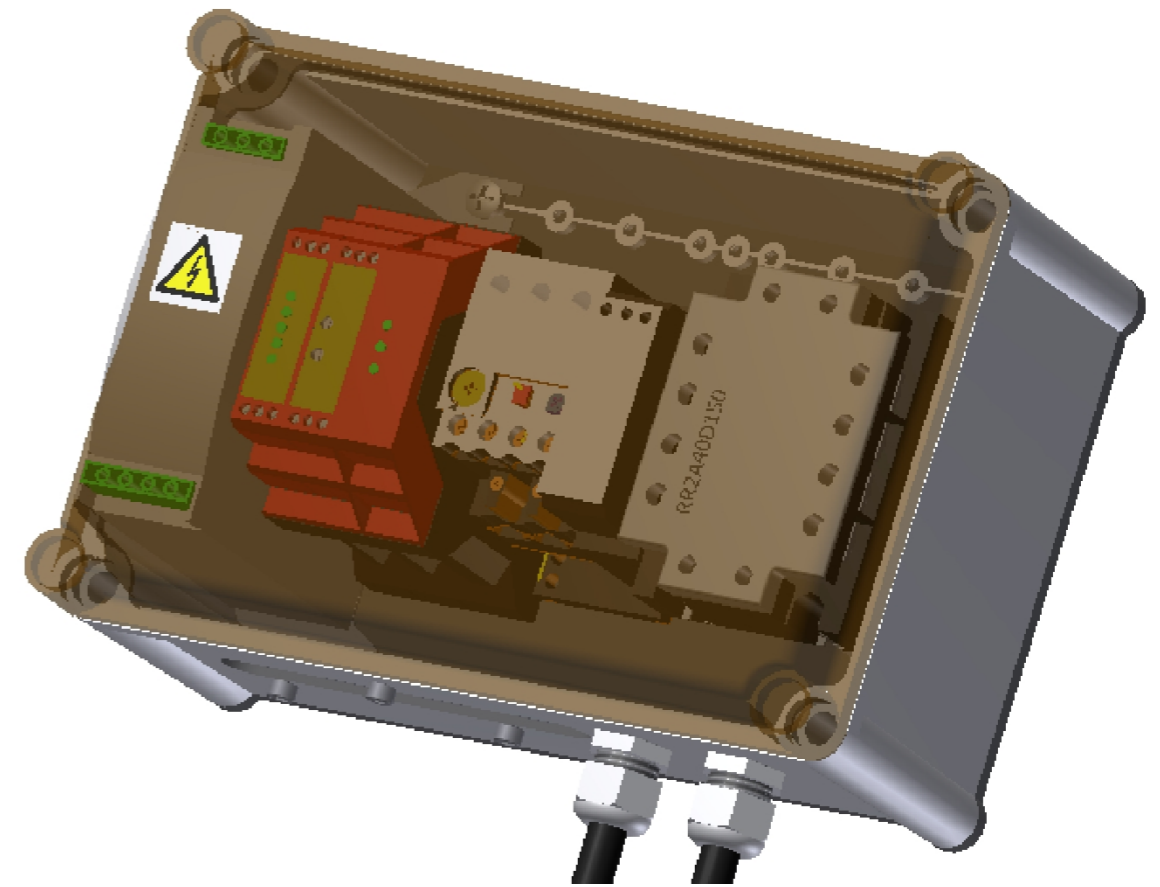

Project title: ERGO 140	Case no.:	Project rev.:	Page 18
Customer:	DCC: &LU		Scale: 1:1
Page title: Component placement	Dwg. no.: 05	Page rev.:	Previous page: 17
File name: 34.140-10.03.04_external_use	Eng. (proj/page): CE / CE	Last print: 22-12-2017	Next page: 19
Page ref.:	Appr. (date/init):	Last edit: 22-12-2017	Total no. of pages: 25

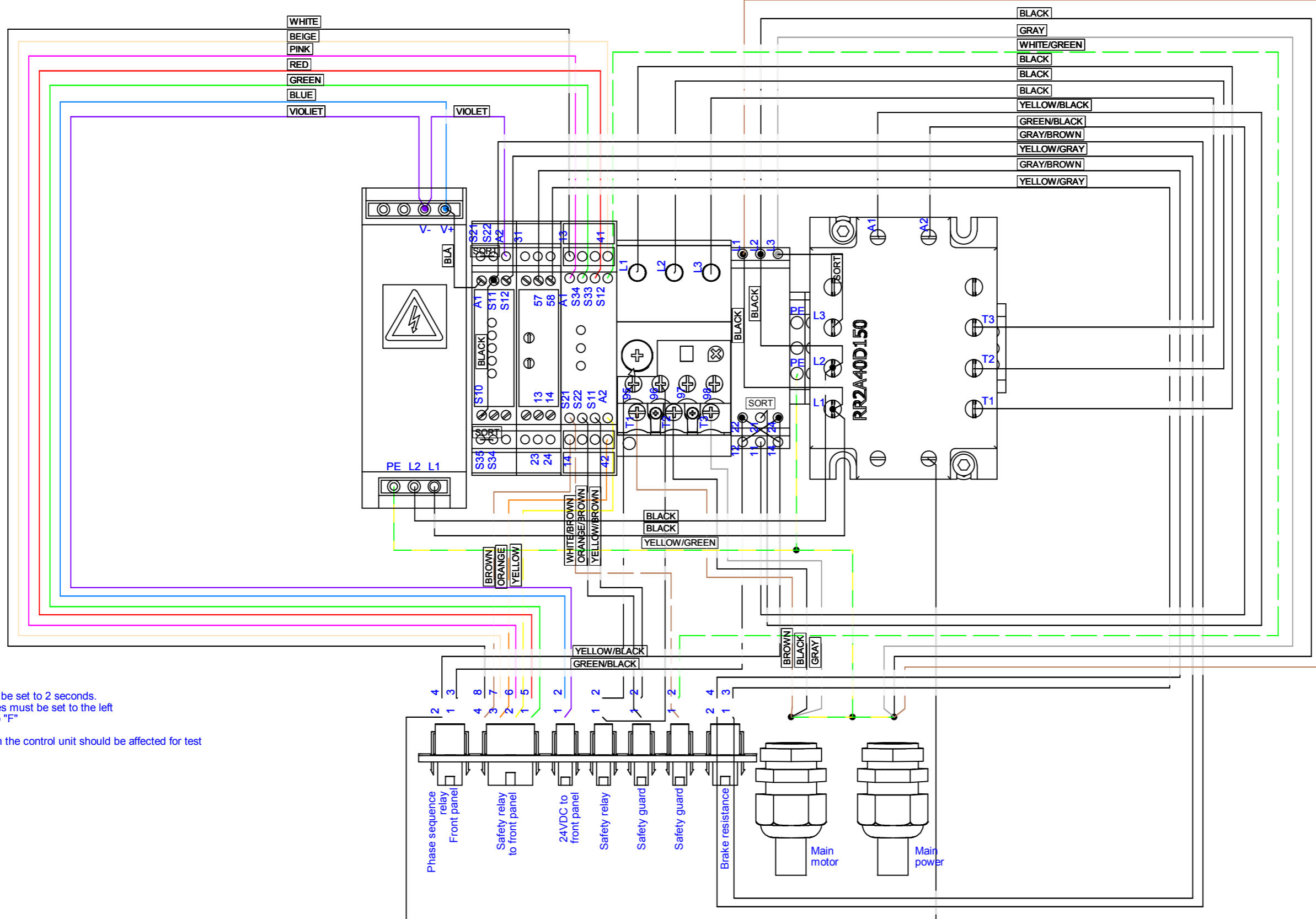

Notes:

1: The relay must be set to 2 seconds.
 i.e. all DIP switches must be set to the left
 and timer 1 & 2 to "F"

2: Reset button on the control unit should be affected for test

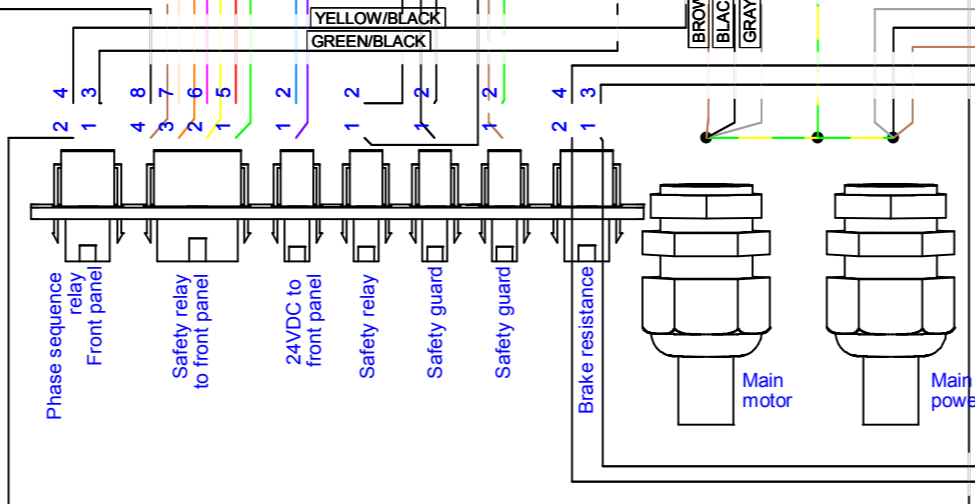

Project title: ERGO 140	Case no.:	Project rev.:	Page 19
Customer:	DCC: &LU		Scale: 1:1
Page title: Cable connection	Dwg. no.: 06	Page rev.:	Previous page: 18
File name: 34.140-10.03.04_external_use	Eng. (proj/page): CE / CE	Last print: 22-12-2017	Next page: 20
Page ref.:	Appr. (date/init):	Last edit: 22-12-2017	Total no. of pages: 25