

ERGO 200 VL-4

380-480VAC

PCSCHEMATIC Automation

A/S WODSCHOW & Co.
Kirkebjerg Søpark 6
DK-2605 Brøndby, Denmark
www.bearvarimixer.dk



Projekttitel: ERGO 200 VL-4	Sagsnr.:	Projektrev.:	Side 1
Kunde:			Målestok: 1:1
Sidetitel: Diagram	Tegningsnr.:	Siderev.:	Forrige side:
Filnavn: 35.200-10.03.04_external_use	Konstr. (projekt/side): CE / CE	Sidst udskrevet: 22-12-2017	Næste side: 2
Sideref.:	Godk. (dato/init):	Sidst rettet: 31-07-2017	Antal sider ialt: 25

Documentation Info

This electrical documentation fits ERGO 200

- ENG. version
- UL approval
- 380-480VAC

Notes

There will be several variants of charts like this:

- 1: With and without brakes
- 2: With and without transformer
- 3: UL or CE approvals

Further, it should be noted that there will be some old versions which will be phase objections along the way, this problem will this be rectified.

Revision descriptions

PCSCHEMATIC Automation

A/S WODSCHOW & Co.

Kirkebjerg Søpark 6
DK-2605 Brøndby, Denmark
www.bearvarimixer.dk



Project title: ERGO 200 VL-4	Case no.:	Project rev.:	Page 4
Customer:	DCC: &DB		Scale: 1:1
Page title: Diagram	Dwg. no.:	Page rev.:	Previous page: 3
File name: 35.200-10.03.04_external_use	Eng. (proj/page): CE	Last print: 22-12-2017	Next page: 5
Page ref.:	Appr. (date/init):	Last edit: 21-12-2017	Total no. of pages: 25

Diagrams

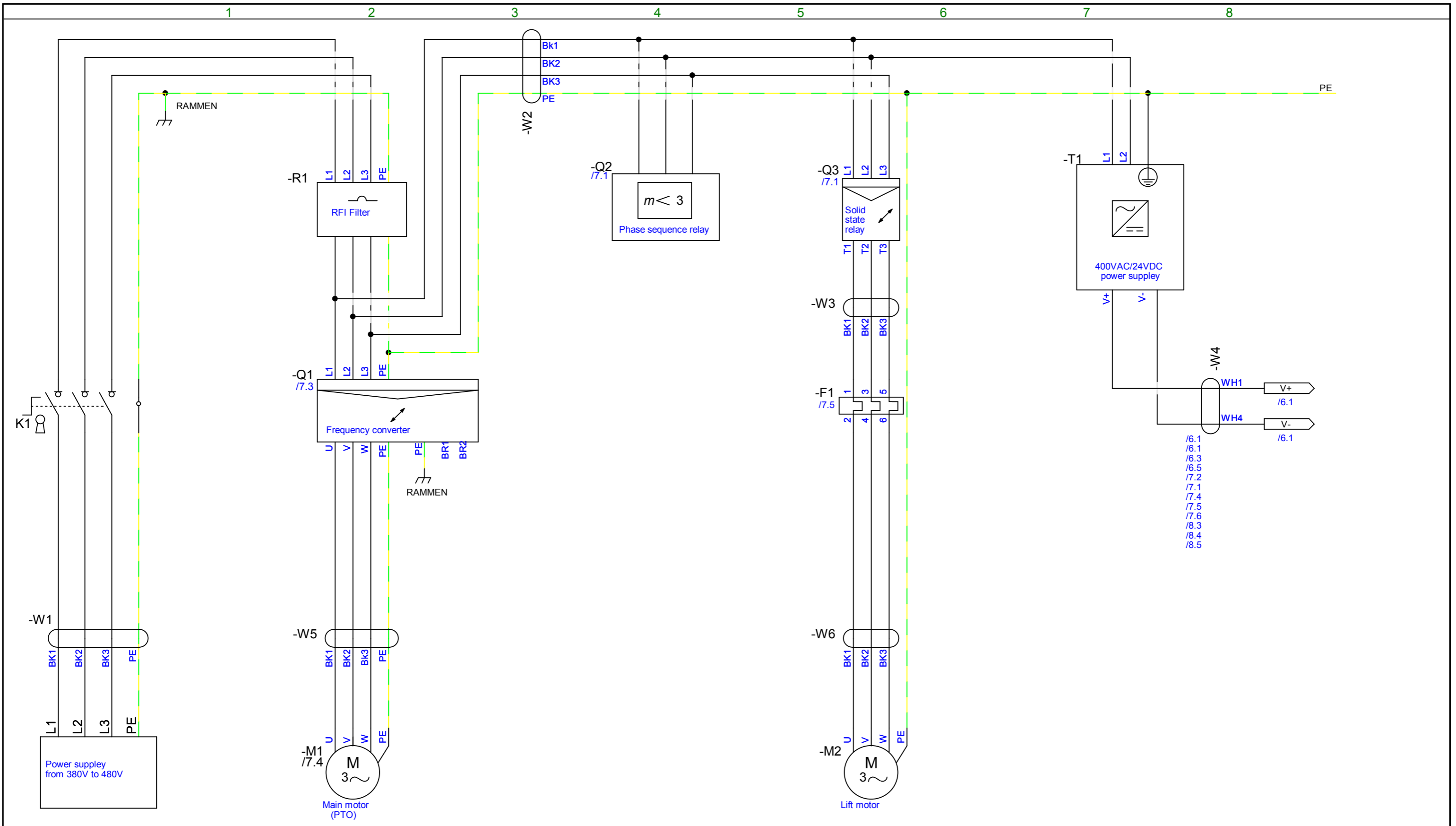

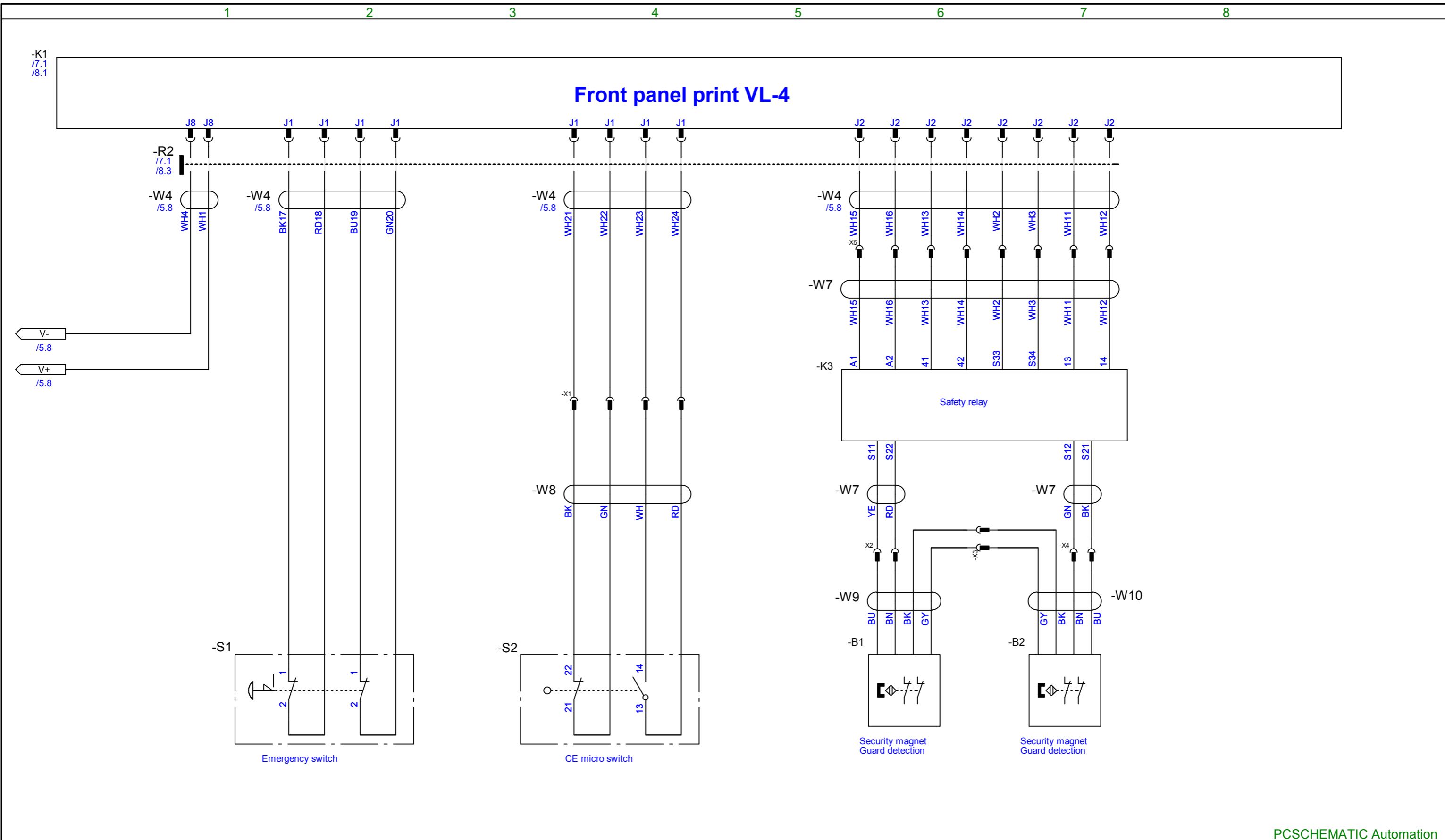

Project title: ERGO 200 VL-4	Case no.:	Project rev.:	Page 6
Customer:	DCC: &FS		Scale: 1:1
Page title: Diagram	Dwg. no.: 02	Page rev.:	Previous page: 5
File name: 35.200-10.03.04_external_use	Eng. (proj/page): CE / CE	Last print: 22-12-2017	Next page: 7
Page ref.:	Appr. (date/init):	Last edit: 21-12-2017	Total no. of pages: 25

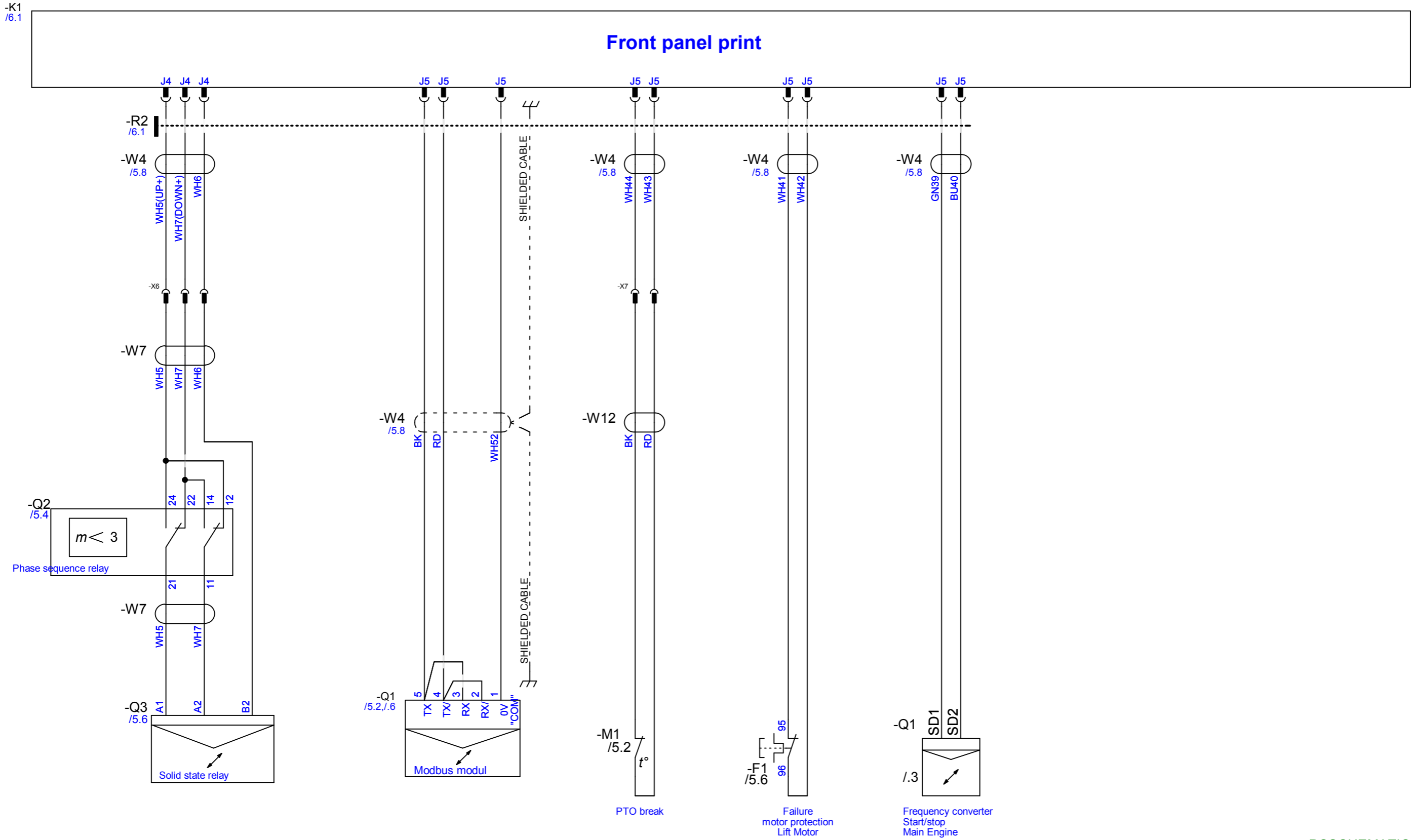

Project title: ERGO 200 VL-4	Case no.:	Project rev.:	Page 7
Customer:	DCC: &FS		Scale: 1:1
Page title: Diagram	Dwg. no.: 03	Page rev.:	Previous page: 6
File name: 35.200-10.03.04_external_use	Eng. (proj/page): CE / CE	Last print: 22-12-2017	Next page: 8
Page ref.:	Appr. (date/init):	Last edit: 21-12-2017	Total no. of pages: 25

-K1
/6.1
/7.1

Front panel print

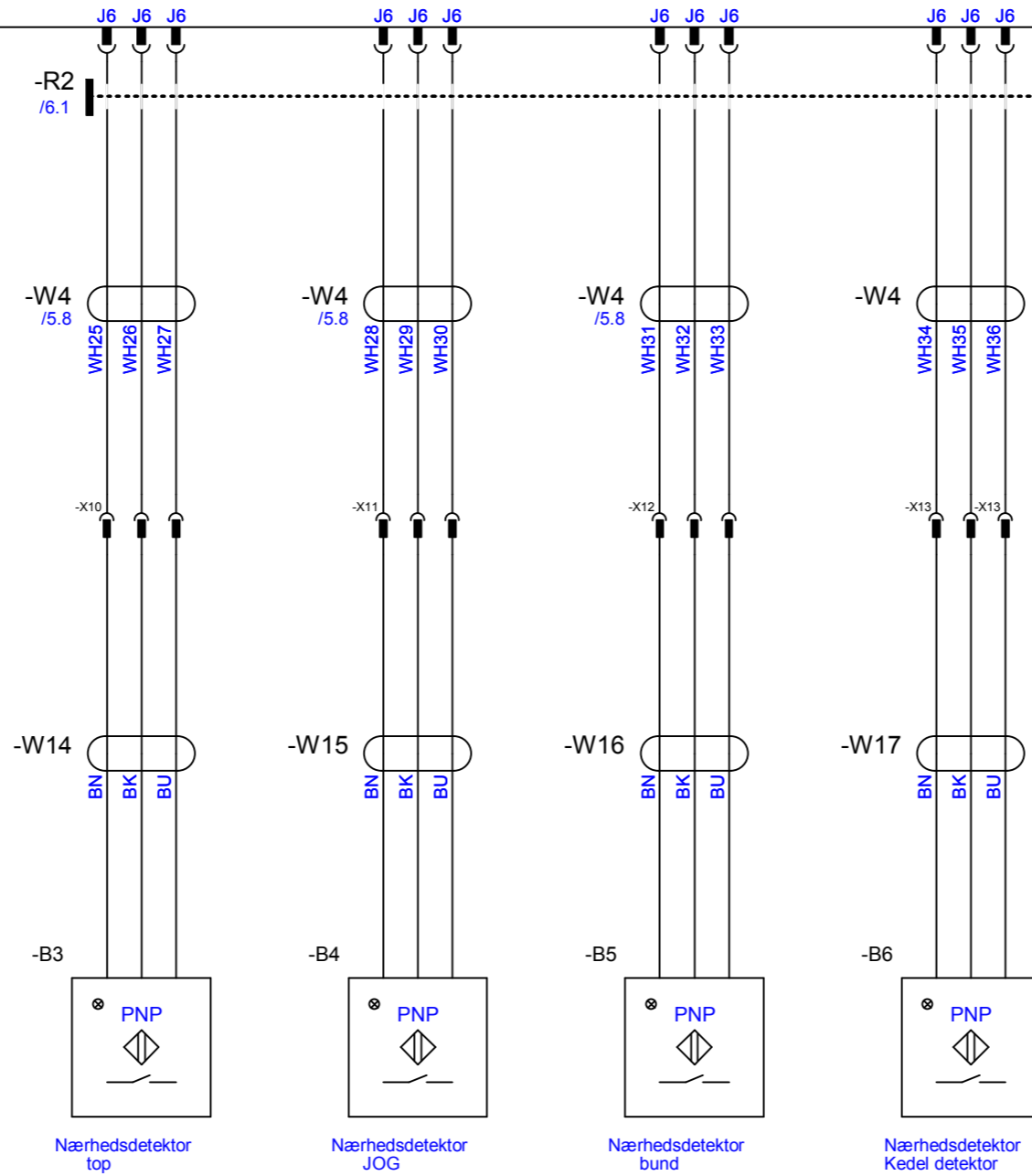

Project title: ERGO 200 VL-4	Case no.:	Project rev.:	Page 8
Customer:	DCC: &FS		Scale: 1:1
Page title: Diagram	Dwg. no.: 04	Page rev.:	Previous page: 7
File name: 35.200-10.03.04_external_use	Eng. (proj/page): CE / CE	Last print: 22-12-2017	Next page: 9
Page ref.:	Appr. (date/init):	Last edit: 21-12-2017	Total no. of pages: 25

Lists

Component	Article	Type	Description	Position
-B1	AE140-512	Safety magnetic senso		/6.6
-B2	AE140-512	Safety magnetic senso MAM-1822-6		/6.7
-B3	AE140-86.1M	Magnet induktiv sensor		/8.3
-B4	AE140-86.1M	Magnet induktiv sensor		/8.4
-B5	AE140-86.1M	Magnet induktiv sensor		/8.5
-B6	AE140-86.1M	Magnet induktiv sensor		/8.6
-F1	AE140-420.4	Safety relay		/5.6
-K1	AE140-561	Print for VL-4 panel		/6.1
-K3	AE140-420	Safety relay		/6.5
-M1	AE140-85	Main motor incl. PTO		/5.2
-M2	WE140-86M	Lift motor incl. actuator		/5.6
-Q1	AE140-601	Frequency converter		/5.2
-Q2	CE61-420.4	Phase sequence relay		/5.4
-Q3	AE140-420.3	Solid state relay		/5.6
-R1	AE140-601.1	RFI Filter		/5.2
-R2	AE140-601.8	Permanent magnet		/6.1
-S1	CE61-174	Emergency switch in panel		/6.2
-S2	CE61-173.1M	Micro switch CE		/6.3
-T1	CE61-414	400VAV/24VDC		/5.7
-W1	WE140-194.14M	Power Cable		/5.1
-W4	WE140-542.5	24VDC main cable		/5.8
-W7	WE140-194.11M	Cable for controlbox, AWG20		/6.5

PCSCHMATIC Automation



From		Cable		To			Type	
	L1	/5.1	-W1	BK1	K1	2	/5.1	Power Cable
	L2	/5.1	-W1	BK2	K1	4	/5.1	Power Cable
	L3	/5.1	-W1	BK3	K1	6	/5.1	Power Cable
	PE	/5.1	-W1	PE	K1	8	/5.1	Power Cable
-Q1	L2	/5.2	-W2	BK2	-Q3	L2	/5.6	Cable drive to electrical box
-Q1	L3	/5.2	-W2	BK3	-Q3	L3	/5.6	Cable drive to electrical box
-Q1	L1	/5.2	-W2	Bk1	-Q2	A2	/5.4	Cable drive to electrical box
-R1	8	/5.2	-W2	PE	-M2	PE	/5.6	Cable drive to electrical box
-Q3	T1	/5.5	-W3	BK1	-F1	1	/5.5	Wire
-Q3	T2	/5.6	-W3	BK2	-F1	3	/5.6	Wire
-Q3	T3	/5.6	-W3	BK3	-F1	5	/5.6	Wire
-K1	4	/7.3	-W4	BK	-Q1	5	/7.3	Shielded Cable
-K1	5	/7.3	-W4	RD	-Q1	4	/7.3	Shielded Cable
-K1	7	/7.3	-W4	WH52	-Q1	1	/7.3	Shielded Cable
			-W4					Shielded Cable
-K1	3	/6.1	-W4	BK17	-S1	1	/6.1	Middle conductor, emergency stop
-K1	5	/6.2	-W4	BU19	-S1	1	/6.2	Middle conductor, emergency stop
-K1	6	/6.2	-W4	GN20	-S1	2	/6.2	Middle conductor, emergency stop
-K1	4	/6.2	-W4	RD18	-S1	2	/6.1	Middle conductor, emergency stop
-K1	11	/7.6	-W4	BU40	-Q1	SD2	/7.6	Start/stop
-K1	10	/7.6	-W4	GN39	-Q1	SD1	/7.6	Start/stop
-T1	V+	/5.7	-W4	WH1	-K1	2	/6.1	24VDC main cable
			-W4	WH4	-K1	1	/6.1	24VDC main cable
-K1	15	/6.6	-W4	WH2	-X5	0	/6.6	Cable safety relay
-K1	16	/6.7	-W4	WH3	-X5	0	/6.7	Cable safety relay



Project title: ERGO 200 VL-4	Case no.:	Project rev.:	Page 11
Customer:	DCC: &MA		Scale: 1:1
Page title: Cable lists	Dwg. no.:	Page rev.:	Previous page: 10
File name: 35.200-10.03.04_external_use	Eng. (proj/page): CE / CE	Last print: 22-12-2017	Next page: 12
Page ref.:	Appr. (date/init):	Last edit: 21-12-2017	Total no. of pages: 25

From		Cable		To			Type	
-K1	17	/6.7	-W4	WH11	-X5	0	/6.7	Cable safety relay
-K1	18	/6.7	-W4	WH12	-X5	0	/6.7	Cable safety relay
-K1	13	/6.6	-W4	WH13	-X5	0	/6.6	Cable safety relay
-K1	14	/6.6	-W4	WH14	-X5	0	/6.6	Cable safety relay
-K1	11	/6.5	-W4	WH15	-X5	0	/6.5	Cable safety relay
-K1	12	/6.6	-W4	WH16	-X5	0	/6.6	Cable safety relay
-K1	1	/7.1	-W4	WH5(UP+)	-X6	0	/7.1	Cable for control lift
-K1	3	/7.1	-W4	WH6	-X6	0	/7.1	Cable for control lift
-K1	2	/7.1	-W4	WH7(DOWN+)	-X6	0	/7.1	Cable for control lift
-K1	7	/6.3	-W4	WH21	-X1	0	/6.3	Kabel micro switch
-K1	8	/6.4	-W4	WH22	-X1	0	/6.4	Kabel micro switch
-K1	9	/6.4	-W4	WH23	-X1	0	/6.4	Kabel micro switch
-K1	10	/6.4	-W4	WH24	-X1	0	/6.4	Kabel micro switch
-K1	10	/8.3	-W4	WH25	-X10	0	/8.3	Kabel PNP top
-K1	3	/8.3	-W4	WH26	-X10	0	/8.3	Kabel PNP top
-K1	2	/8.3	-W4	WH27	-X10	0	/8.3	Kabel PNP top
-K1	5	/8.4	-W4	WH28	-X11	0	/8.4	Kabel PNP JOG
-K1	4	/8.4	-W4	WH29	-X11	0	/8.4	Kabel PNP JOG
-K1	7	/8.4	-W4	WH30	-X11	0	/8.4	Kabel PNP JOG
-K1	6	/8.5	-W4	WH31	-X12	0	/8.5	Kabel PNP bund
-K1	9	/8.5	-W4	WH32	-X12	0	/8.5	Kabel PNP bund
-K1	8	/8.5	-W4	WH33	-X12	0	/8.5	Kabel PNP bund
-K1	1	/8.6	-W4	WH34	-X13	0	/8.6	Kabel PNP Bowl
-K1	12	/8.6	-W4	WH35	-X13	0	/8.6	Kabel PNP Bowl
-K1	11	/8.6	-W4	WH36	-X13	0	/8.6	Kabel PNP Bowl
-K1	8	/7.5	-W4	WH41	-F1	95	/7.5	kabel til termoe relæ
-K1	9	/7.5	-W4	WH42	-F1	96	/7.5	kabel til termoe relæ
-K1	7	/7.4	-W4	WH43	-X7	0	/7.4	Cabel to PTO

PCSCHEMATIC Automation



Project title: ERGO 200 VL-4	Case no.:	Project rev.:	Page 12
Customer:	DCC: &MA		Scale: 1:1
Page title: Cable lists	Dwg. no.:	Page rev.:	Previous page: 11
File name: 35.200-10.03.04_external_use	Eng. (proj/page): CE / CE	Last print: 22-12-2017	Next page: 13
Page ref.:	Appr. (date/init):	Last edit: 21-12-2017	Total no. of pages: 25

From			Cable		To			Type
-K1	6	/7.4	-W4	WH44	-X7	0	/7.4	Cabel to PTO
-Q1	U	/5.2	-W5	BK1	-M1	U	/5.2	Cable for main motor
-Q1	V	/5.2	-W5	BK2	-M1	V	/5.2	Cable for main motor
-Q1	W	/5.2	-W5	Bk3	-M1	W	/5.2	Cable for main motor
-Q1	PE	/5.2	-W5	PE	-M1	PE	/5.2	Cable for main motor
-F1	2	/5.5	-W6	BK1	-M2	U	/5.5	Cable for lift motor
-F1	4	/5.6	-W6	BK2	-M2	V	/5.6	Cable for lift motor
-F1	6	/5.6	-W6	BK3	-M2	W	/5.6	Cable for lift motor
-K3	S21	/6.7	-W7	BK	-X4	0	/6.7	Mellemleder
-K3	S12	/6.7	-W7	GN	-X4	0	/6.7	Mellemleder
-K3	S22	/6.6	-W7	RD	-X2	0	/6.6	Mellemleder
-K3	S11	/6.6	-W7	YE	-X2	0	/6.6	Mellemleder
-X5	0	/6.6	-W7	WH2	-K3	S33	/6.6	Cable for controlbox, AWG20
-X5	0	/6.7	-W7	WH3	-K3	S34	/6.7	Cable for controlbox, AWG20
-X5	0	/6.7	-W7	WH11	-K3	13	/6.7	Cable for controlbox, AWG20
-X5	0	/6.7	-W7	WH12	-K3	14	/6.7	Cable for controlbox, AWG20
-X5	0	/6.6	-W7	WH13	-K3	41	/6.6	Cable for controlbox, AWG20
-X5	0	/6.6	-W7	WH14	-K3	42	/6.6	Cable for controlbox, AWG20
-X5	0	/6.5	-W7	WH15	-K3	A1	/6.5	Cable for controlbox, AWG20
-X5	0	/6.6	-W7	WH16	-K3	A2	/6.6	Cable for controlbox, AWG20
-Q2	21	/7.1	-W7	WH5	-Q3	A1	/7.1	Mellemleder
-Q2	11	/7.1	-W7	WH7	-Q3	A2	/7.1	Mellemleder
-X6	0	/7.1	-W7	WH5	-Q2	12	/7.1	Mellemleder
-X6	0	/7.1	-W7	WH6	-Q3	B2	/7.1	Mellemleder
-X6	0	/7.1	-W7	WH7	-Q2	14	/7.1	Mellemleder

PCSCHEMATIC Automation



From		Cable	To		Type
-X1	0	/6.3	-W8	BK	-S2 22 /6.3 Kabel micro switch
-X1	0	/6.4	-W8	GN	-S2 21 /6.3 Kabel micro switch
-X1	0	/6.4	-W8	RD	-S2 13 /6.4 Kabel micro switch
-X1	0	/6.4	-W8	WH	-S2 14 /6.4 Kabel micro switch
-X3	0	/6.6	-W9	BK	-B1 3 /6.6 Kabel til kedel detektion
-X2	0	/6.6	-W9	BN	-B1 2 /6.6 Kabel til kedel detektion
-X2	0	/6.6	-W9	BU	-B1 1 /6.6 Kabel til kedel detektion
-X3	0	/6.6	-W9	GY	-B1 4 /6.6 Kabel til kedel detektion
-X3	0	/6.6	-W10	BK	-B2 1 /6.7 Kabel til kedel detektion
-X4	0	/6.7	-W10	BN	-B2 4 /6.7 Kabel til kedel detektion
-X4	0	/6.7	-W10	BU	-B2 3 /6.7 Kabel til kedel detektion
-X3	0	/6.6	-W10	GY	-B2 2 /6.7 Kabel til kedel detektion
-X7	0	/7.4	-W12	BK	-M1 1 /7.4 PTO kabel
-X7	0	/7.4	-W12	RD	-M1 2 /7.4 PTO kabel
-X10	0	/8.3	-W14	BK	-B3 /8.3 PNP Sensor kabel top
-X10	0	/8.3	-W14	BN	-B3 /8.3 PNP Sensor kabel top
-X10	0	/8.3	-W14	BU	-B3 /8.3 PNP Sensor kabel top
-X11	0	/8.4	-W15	BK	-B4 /8.4 PNP Sensor kabel JOG
-X11	0	/8.4	-W15	BN	-B4 /8.4 PNP Sensor kabel JOG
-X11	0	/8.4	-W15	BU	-B4 /8.4 PNP Sensor kabel JOG
-X12	0	/8.5	-W16	BK	-B5 /8.5 PNP sensor kabel bund
-X12	0	/8.5	-W16	BN	-B5 /8.5 PNP sensor kabel bund



Page no.	Title	Page remarks	Revision	Last edit
1	Diagram			31-07-2017
2	Index			31-07-2017
3	Table of contents			22-12-2017
4	Diagram			21-12-2017
	Diagrams			
5	Diagram			21-12-2017
6	Diagram			21-12-2017
7	Diagram			21-12-2017
8	Diagram			21-12-2017
	Lists			
9	Part list			21-12-2017
10	Component list			21-12-2017
11	Cable lists			21-12-2017
16	Page remarks (log)			22-12-2017

PCSCHEMATIC Automation



Page no.	Title	Page remarks	Revision	Last edit
	Arrangement			
18	Komponentplan			22-12-2017
19	Cable plan			22-12-2017
	Print diagram			
20	Diagram			22-12-2017
21	Diagram			31-07-2017

PCSCHEMATIC Automation



Arrangement

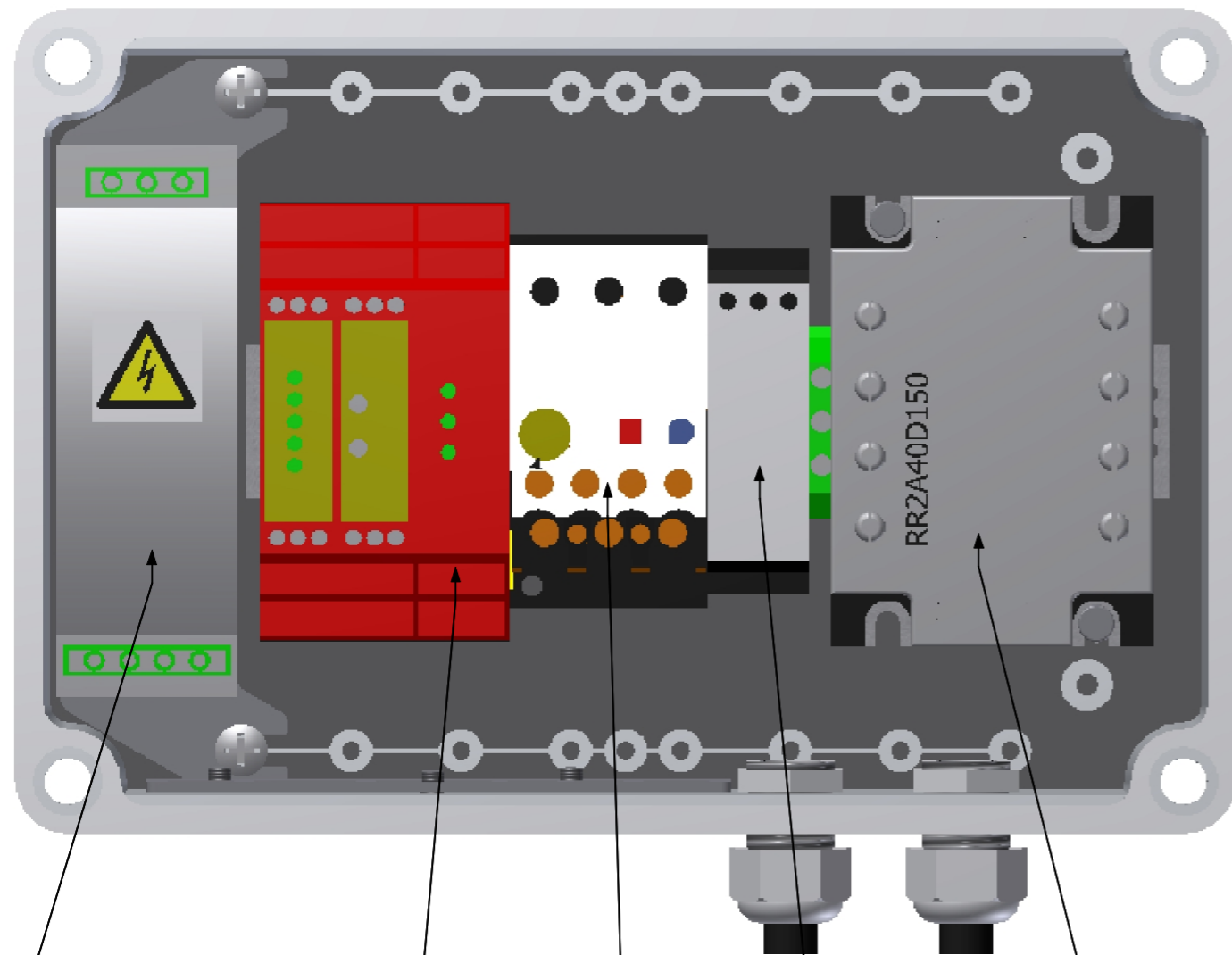

400VAC/24VDC
power supply
Item no. CE61-414

Safety relay
Item no. CE61-420

Over Current Relay
Item no. AE140-420.4

Phase sequencing relay
Item no. CE61-420.4

Solid state relay
Item no. CE140-420.3

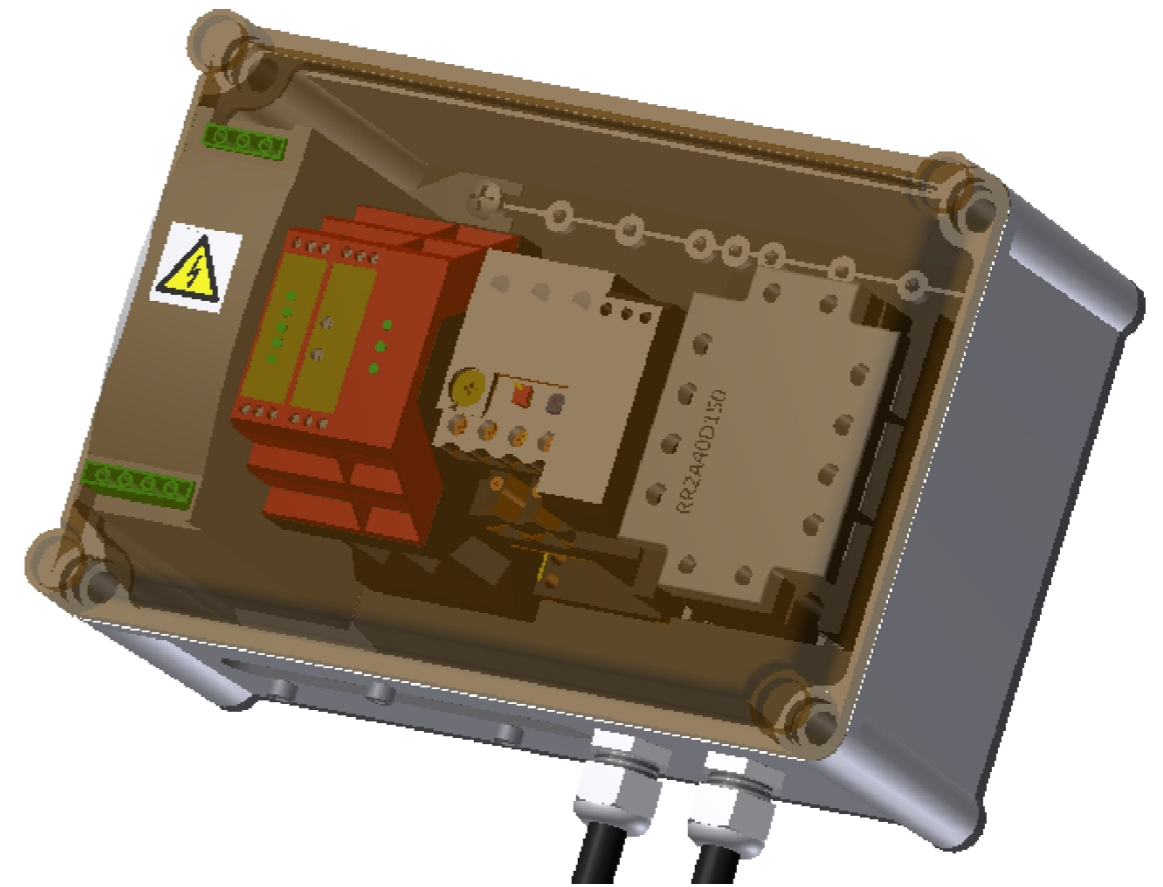

Project title: ERGO 200 VL-4	Case no.:	Project rev.:	Page 18
Customer:	DCC: &LU		Scale: 1:1
Page title: Komponentplan	Dwg. no.: 05	Page rev.:	Previous page: 17
File name: 35.200-10.03.04_external_use	Eng. (proj/page): CE / CE	Last print: 22-12-2017	Next page: 19
Page ref.:	Appr. (date/init):	Last edit: 22-12-2017	Total no. of pages: 25

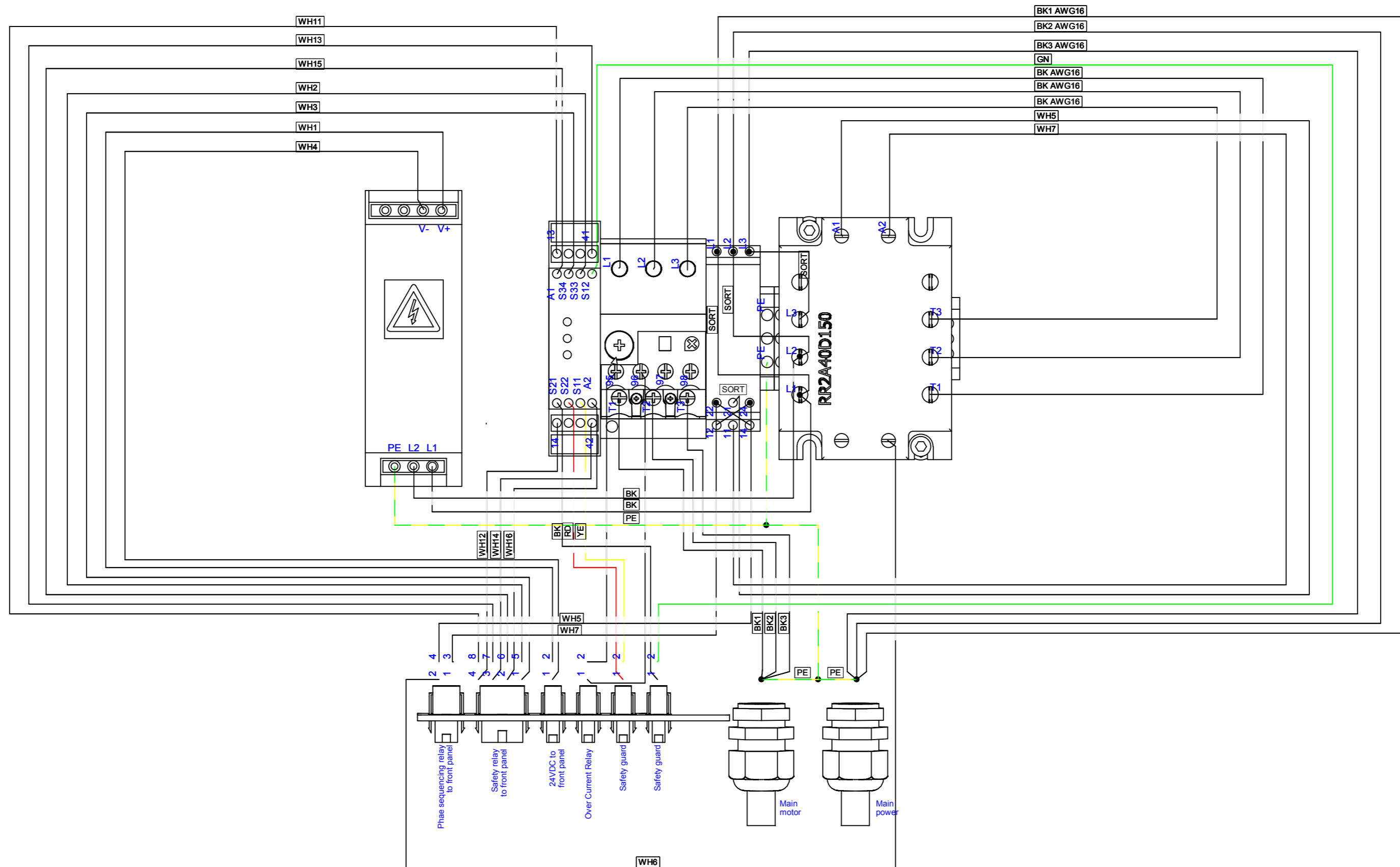

Project title: ERGO 200 VL-4	Case no.:	Project rev.:	Page 19
Customer:	DCC: &LU		Scale: 1:1
Page title: Cable plan	Dwg. no.: 06	Page rev.:	Previous page: 18
File name: 35.200-10.03.04_external_use	Eng. (proj/page): CE / CE	Last print: 22-12-2017	Next page: 20
Page ref.:	Appr. (date/init):	Last edit: 22-12-2017	Total no. of pages: 25